

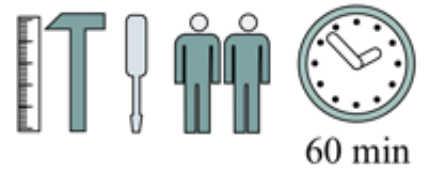

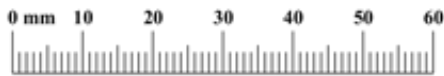

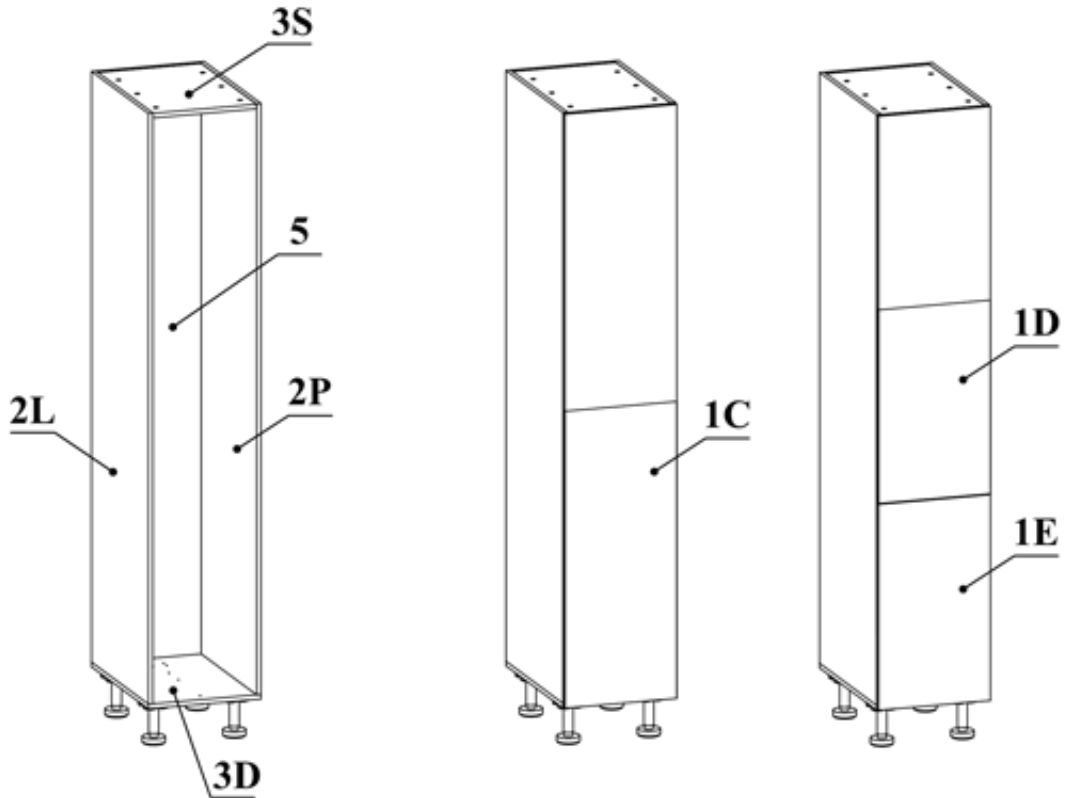





**Assembly Instructions for cabinets: EURO S40-C/222/60**



A1 X18 	B4 X14 	B5 X14 	G5 X14 	Z2 X2 	UP16 X19 
D27 X16 	I15 X4 	B11 X6 	G4 X6 	D30 X12 	G2 X1 
I16 X6 	<p>Check all the items are in your box according to the list on this manual. If you are missing anything, please check all other boxes first and then send us an email with a list of the parts you need.</p>				

EURO S40-C/222/60

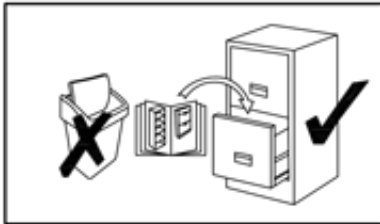
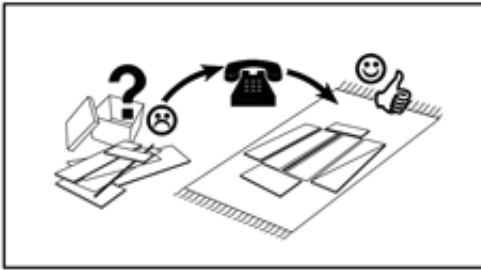

Keep your product assembly manual in a safe place until your kitchen is finished.

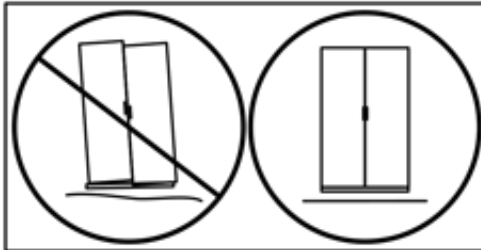

Be sure to assemble your cabinets on a flat surface and keep them straight and square.

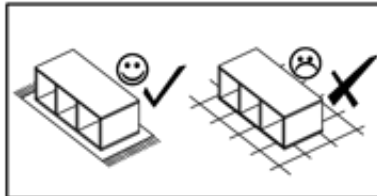
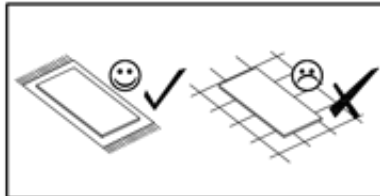

Assemble your cabinets on a rug or a surface that will not scratch or damage them.

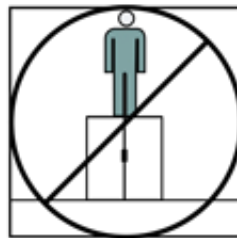
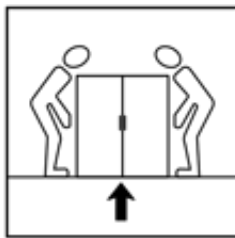

Do not push cabinets into place. Get someone to help you lift the cabinets into place, or you could risk damaging the feet.  
Do not stand on the cabinets.



Once protective film on thermal wrap doors is removed, do not clean for 7 days. This allows the surface to harden. Only clean the cabinets with a small amount of warm water or non harsh chemicals.

EURO S40-C/222/60

1

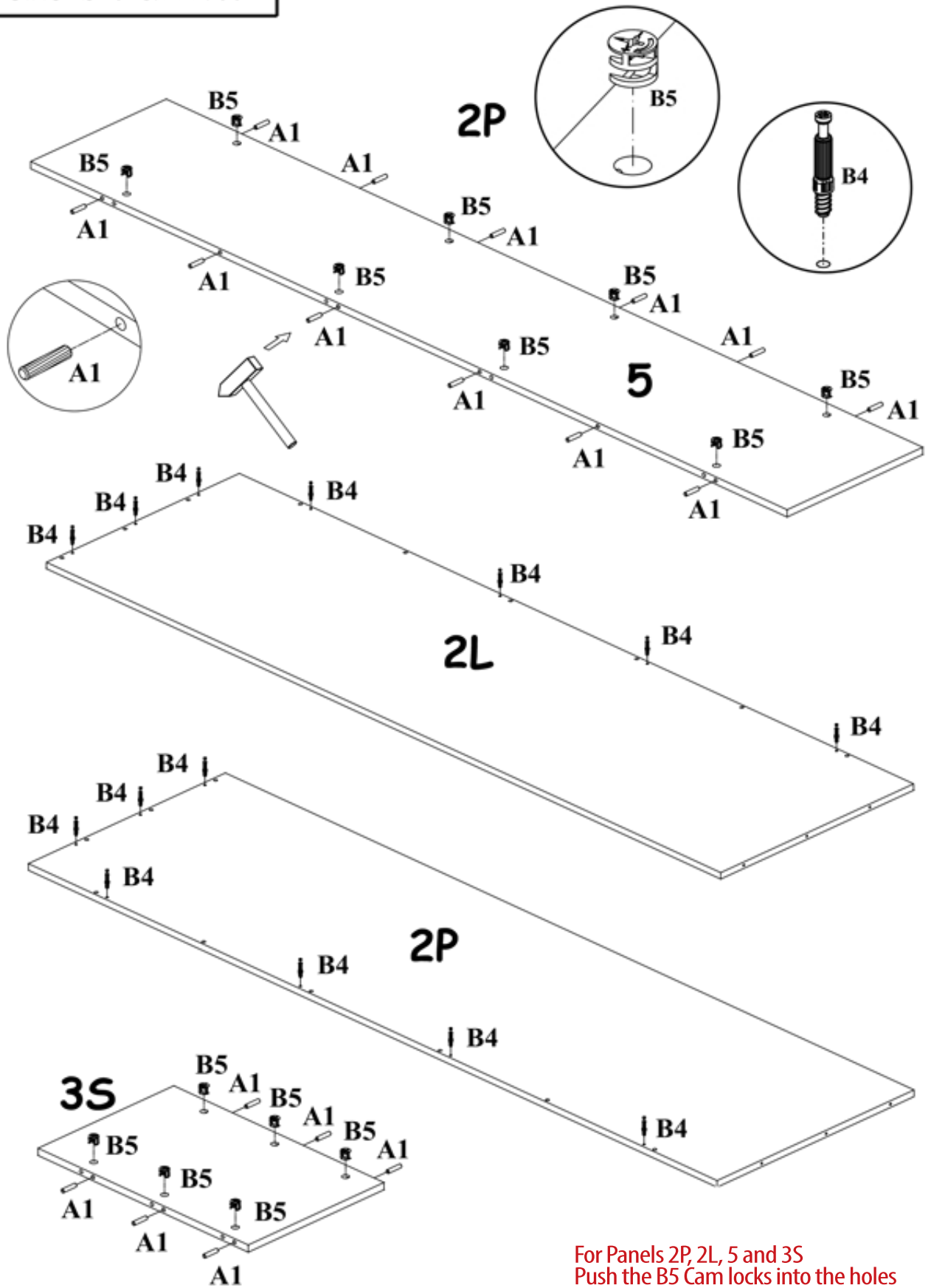

For Panels 2P, 2L, 5 and 3S  
 Push the B5 Cam locks into the holes  
 on the panels. Screw in the B4 Cam  
 screws. Knock in A1 dowells.

EURO S40-C/222/60

2

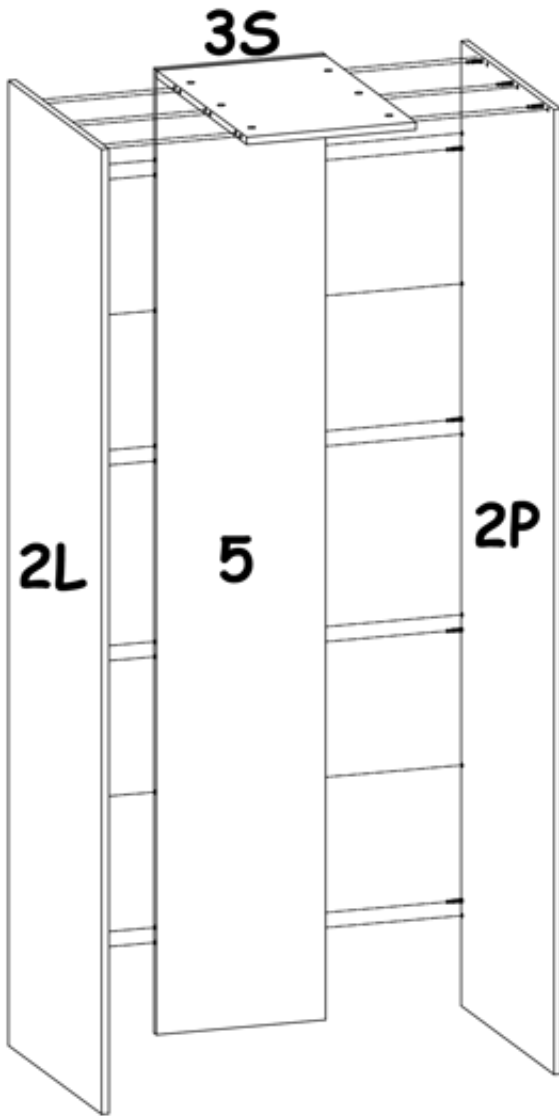

3

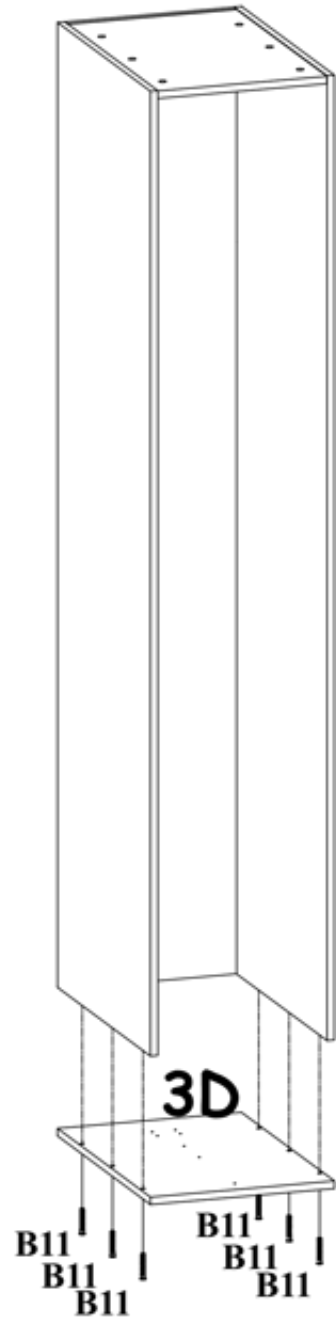

Push the panels together so that the B4 cam screws slide into the holes in line with the B5 cam locks. Start with one side panel, the backpanel and the top panel. Now attach the other side panel. Tighten the B5 cam locks, then push on G5 caps. Now screw on the base panel with the B11 screws and allen key tool. Push G4 caps over the screws.

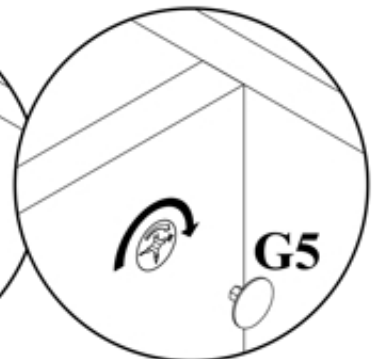
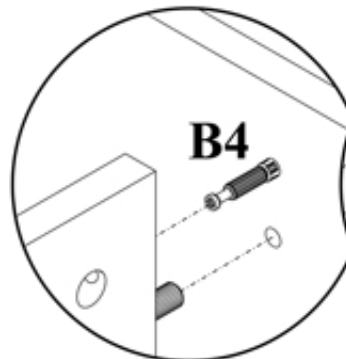
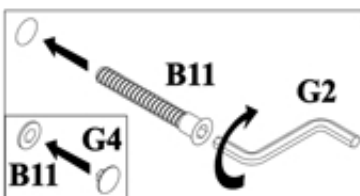

EURO S40-C/222/60

4

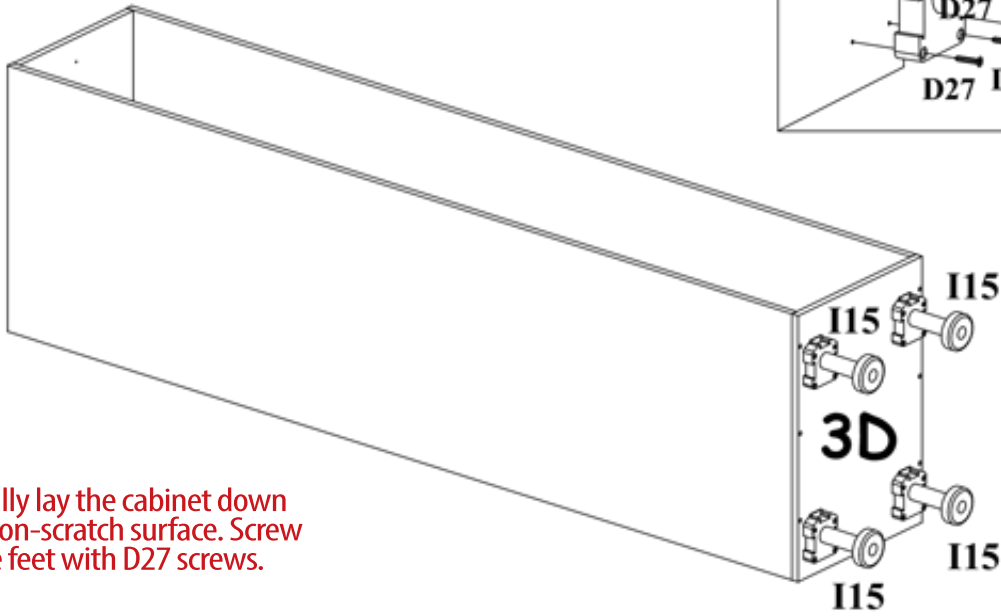

Carefully lay the cabinet down on a non-scratch surface. Screw on the feet with D27 screws.

5

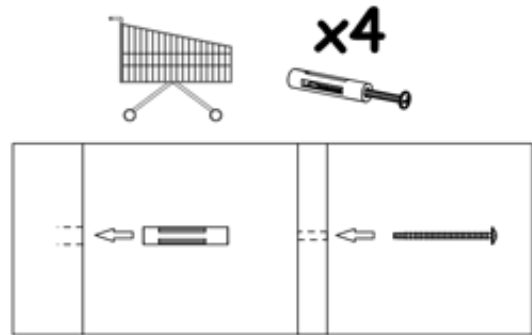
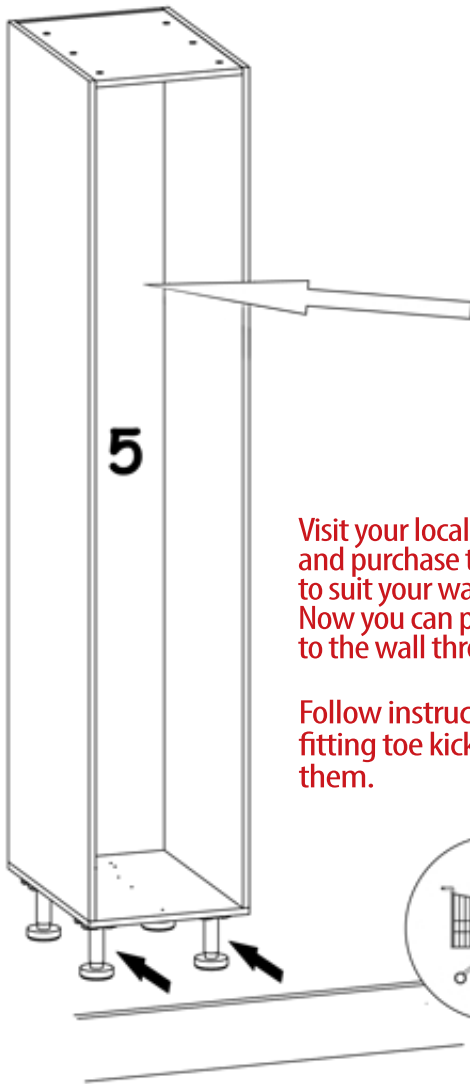

Visit your local hardware store to confirm and purchase the correct type of wall fixings to suit your wall type. Now you can predrill and screw your cabinet to the wall through the back panel.

Follow instructions from our website for fitting toe kicks if you have purchased them.

