

EURO

S105/105N/222/60

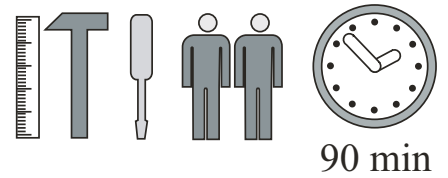

A1 X36 ø8x36	B4 X32	B5 X32 ø15x12	G5 X32	D30 X4 USØ3,5x16	
I2 X8	G3 X6 Ø35	B11 X20 Ø7x50	G4 X20	D10 X12 USØ3,5x13	G2 X1
Z2 X24 Ø5	G7 X16	E15 X6	E2 X6 H=0	AR1 X2	AR2 X2

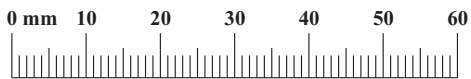
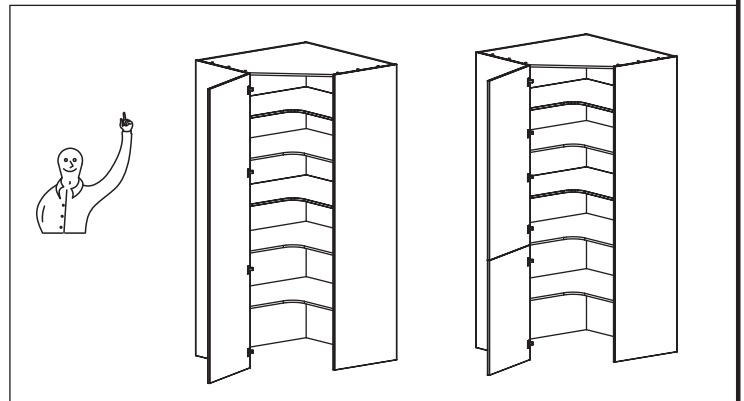
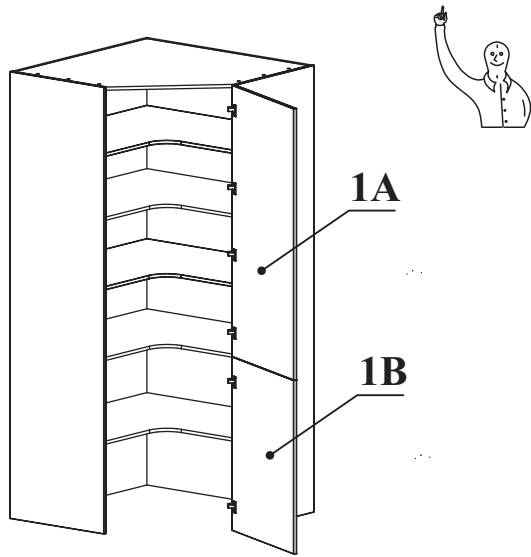
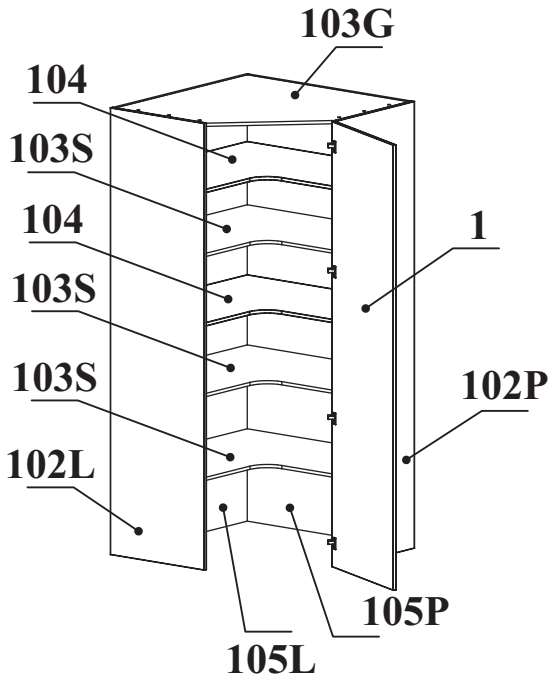
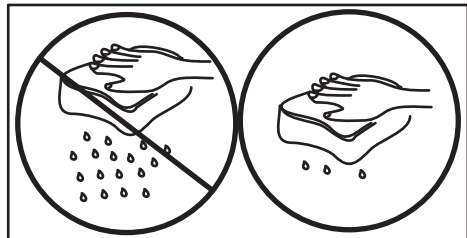
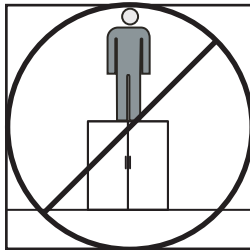
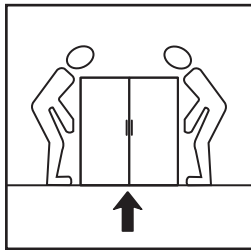
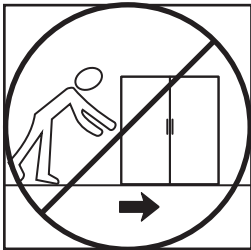
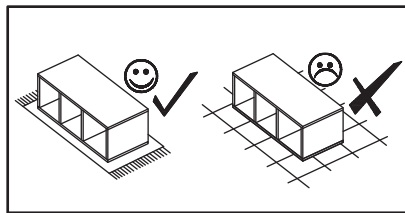
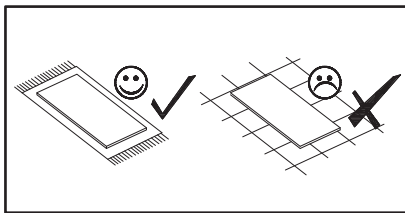
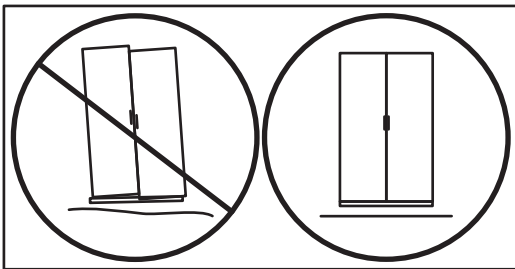
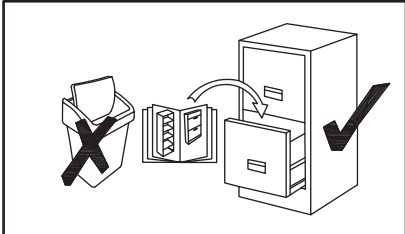
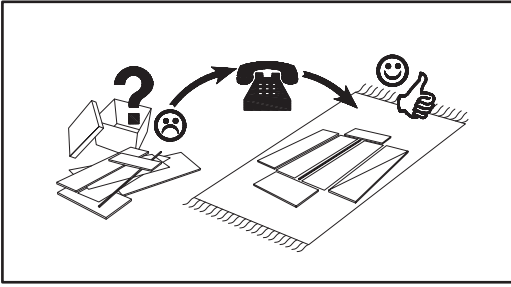

1

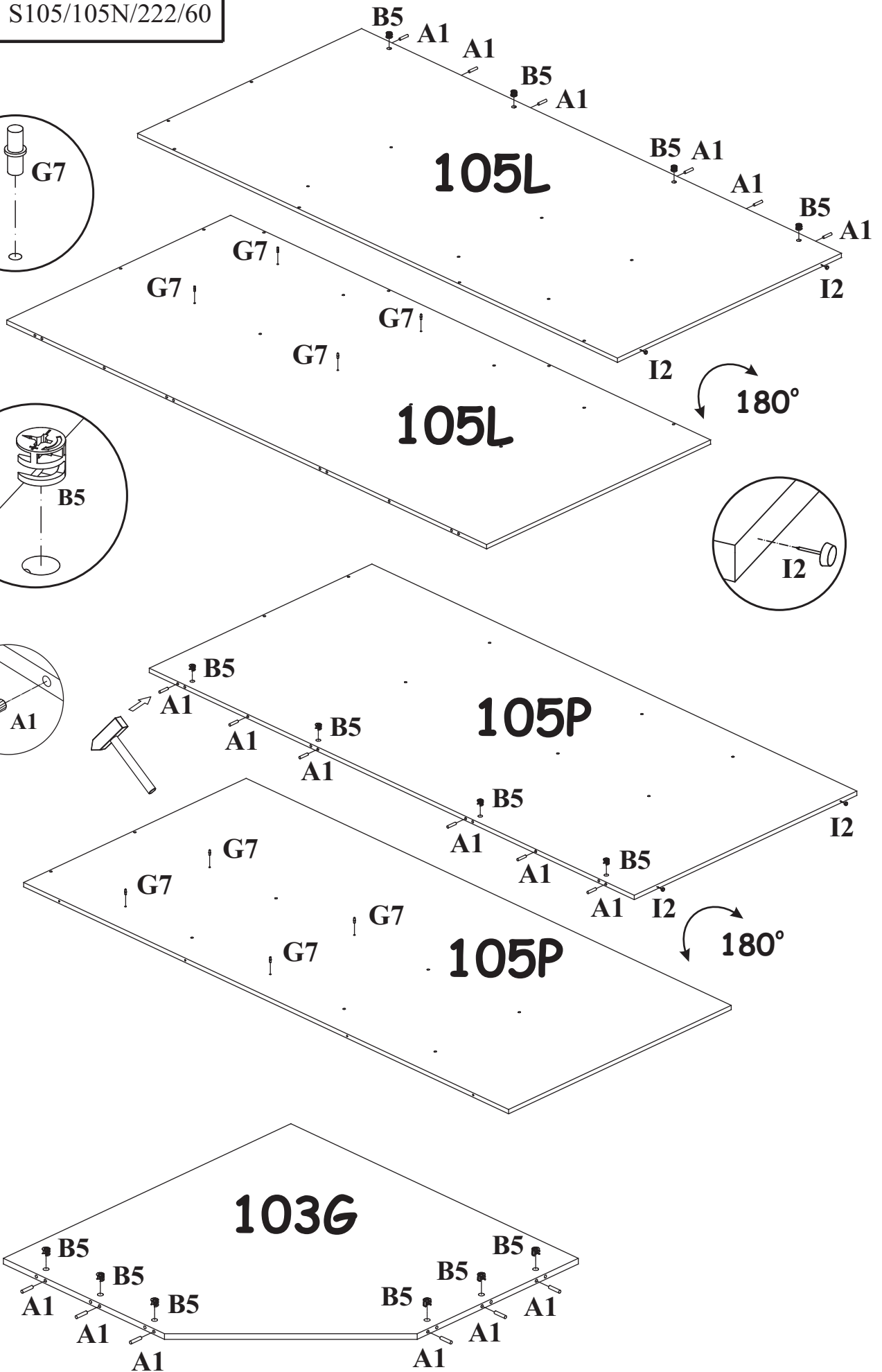
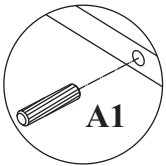
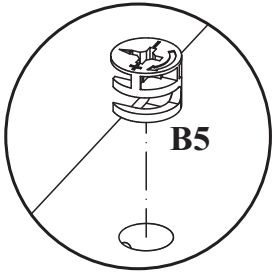
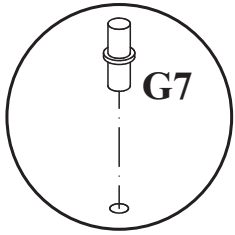

2

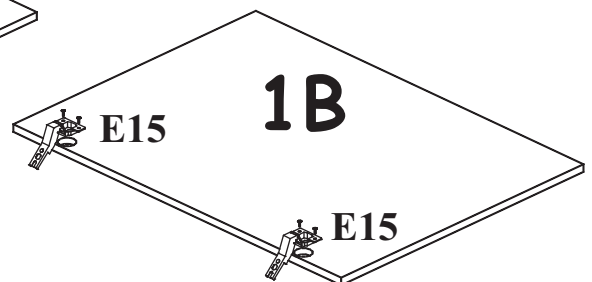
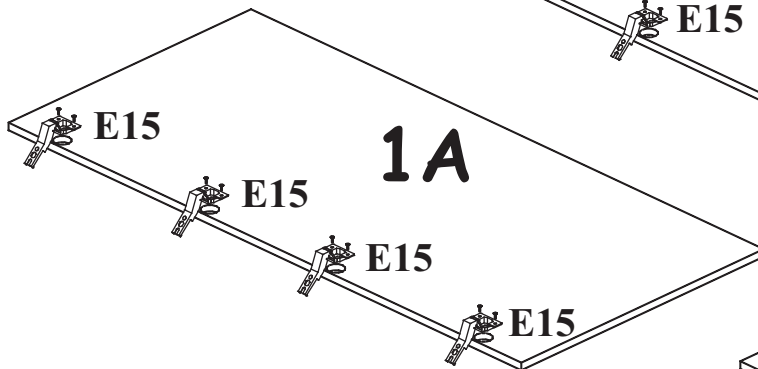
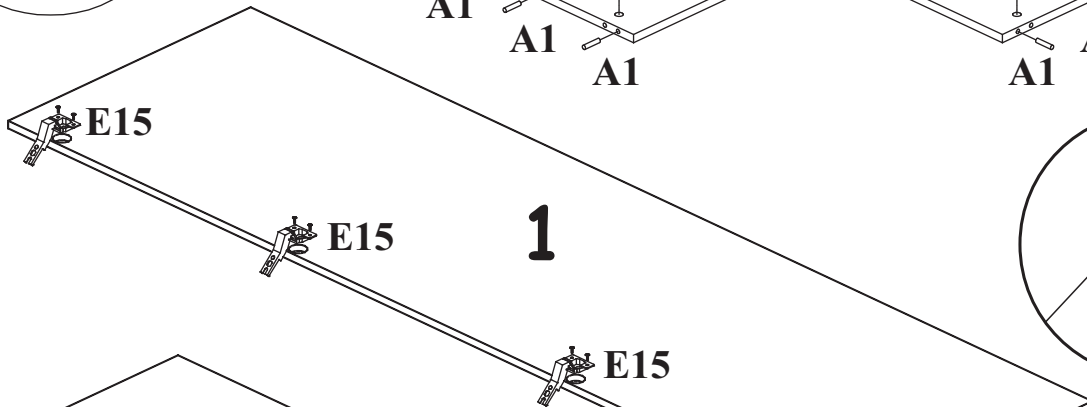
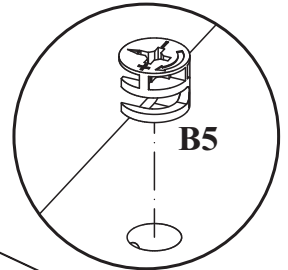
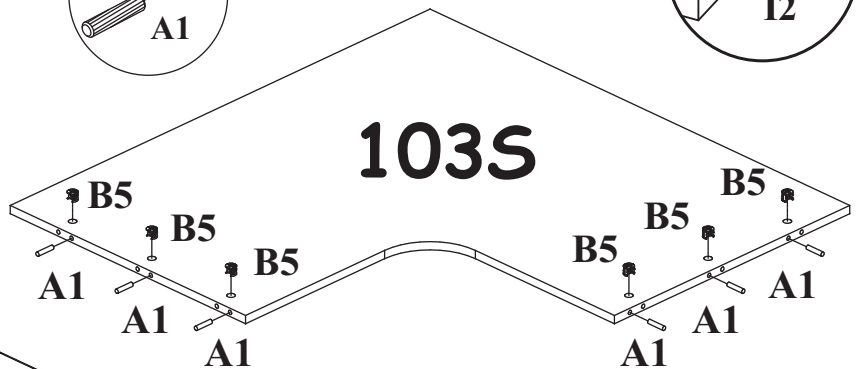
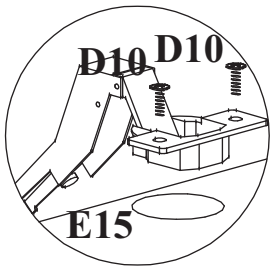
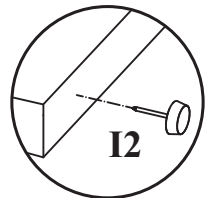
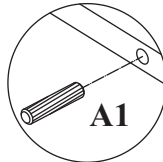
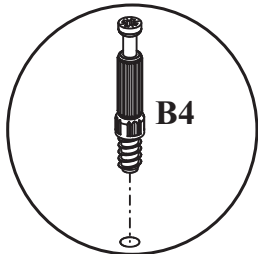
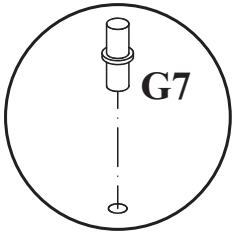
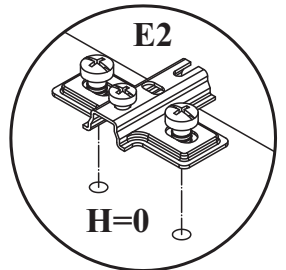
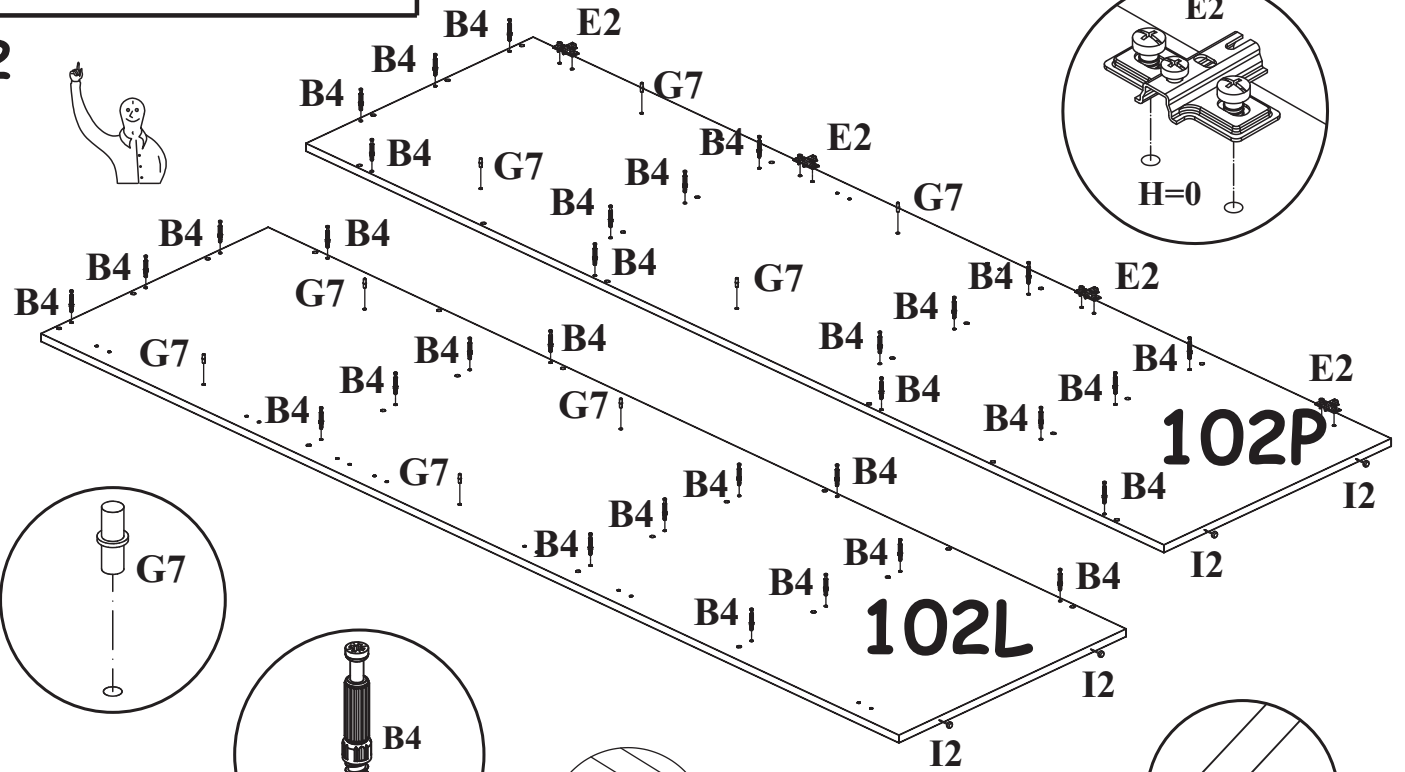

3

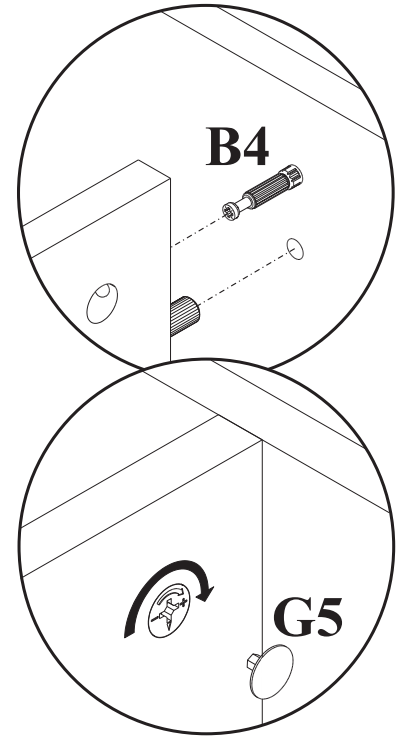
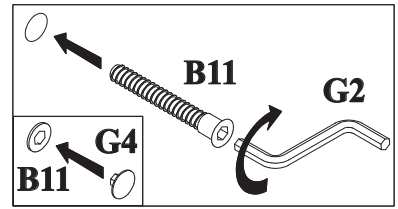
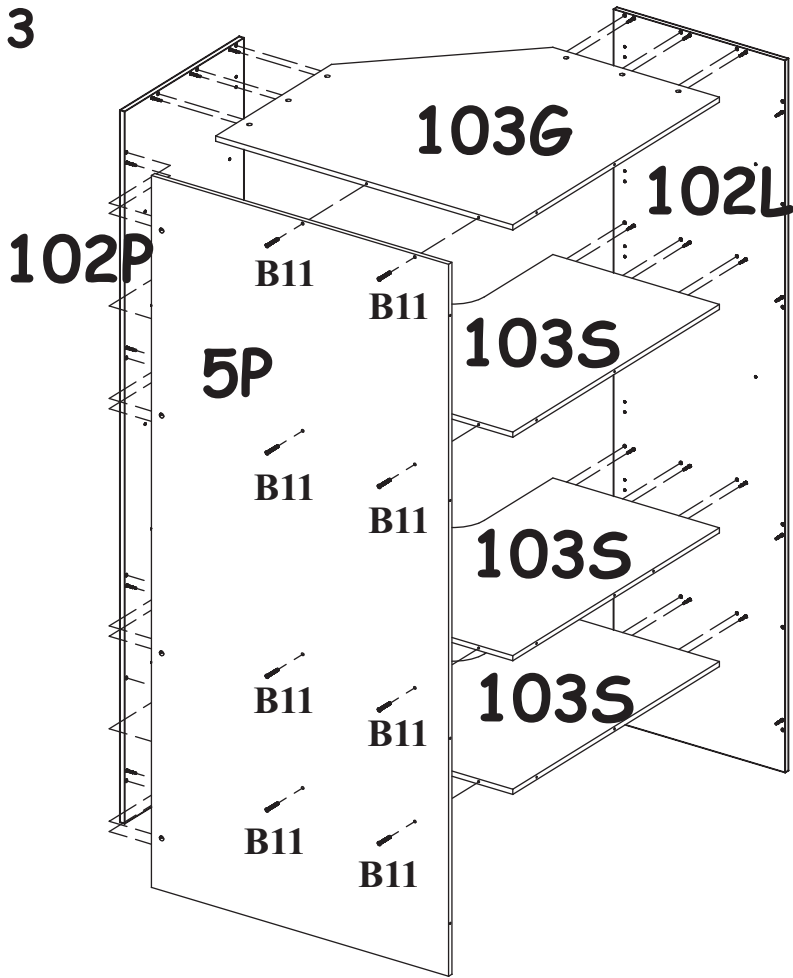

4

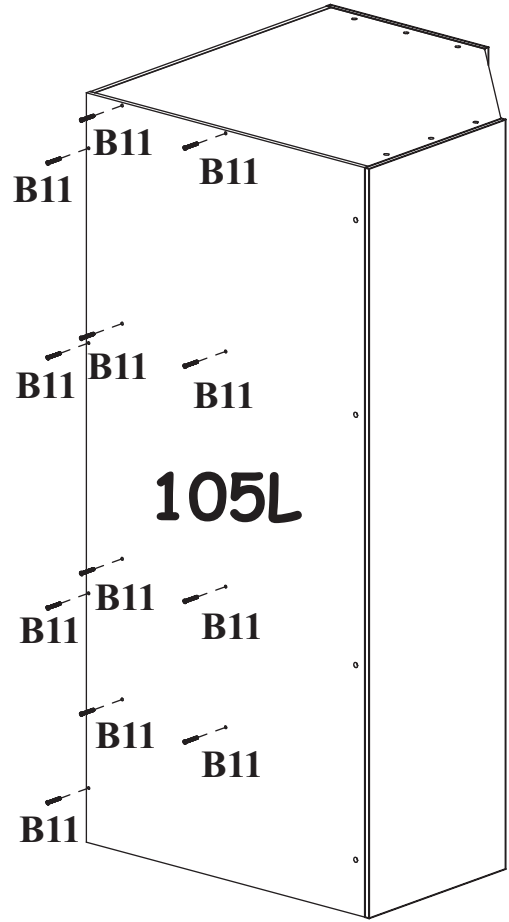
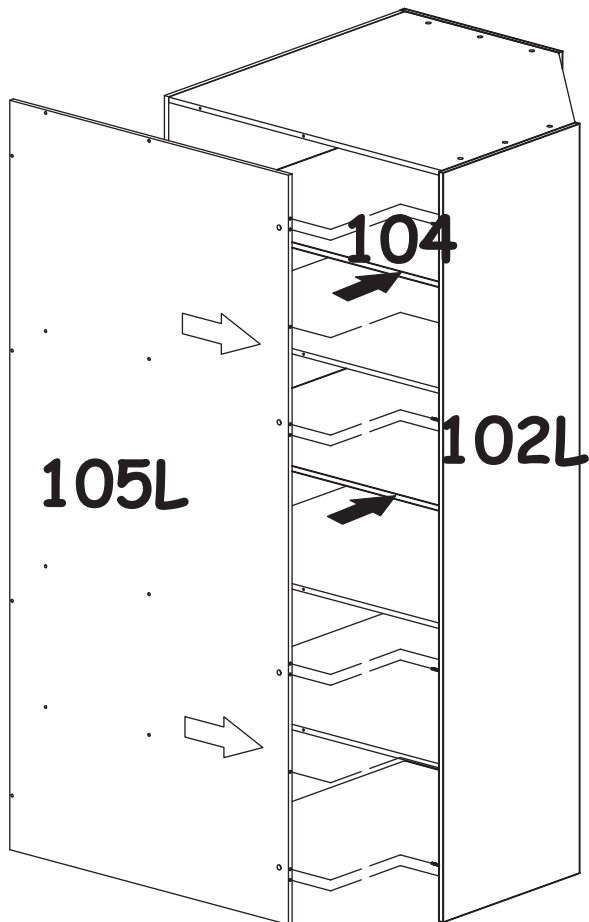

5

